

10A 45V Planar Schottky Diode
■ Applications

Device optimized for low forward voltage drop to maximize efficiency in Power Supply applications

- AC-DC Adaptors
- DC-DC Converters

■ Features

- Schottky Barrier Chip
- Guard Ring Die Construction for Transient Protection
- Low Power Loss, High Efficiency
- High Surge Capability
- High Current Capability and Low Forward Voltage Drop
- Halogen Free and RoHS Compliant

■ Product Summary

V_{RRM}	45	V
$I_F@T_c=25^\circ\text{C}$	5 x 2	A
$V_{F,MAX}@5A, T_c=25^\circ\text{C}$	0.55	V
$V_{F,MAX}@5A, T_c=125^\circ\text{C}$	0.45	V
$I_{R,MAX}@T_c=25^\circ\text{C}$	0.1	mA

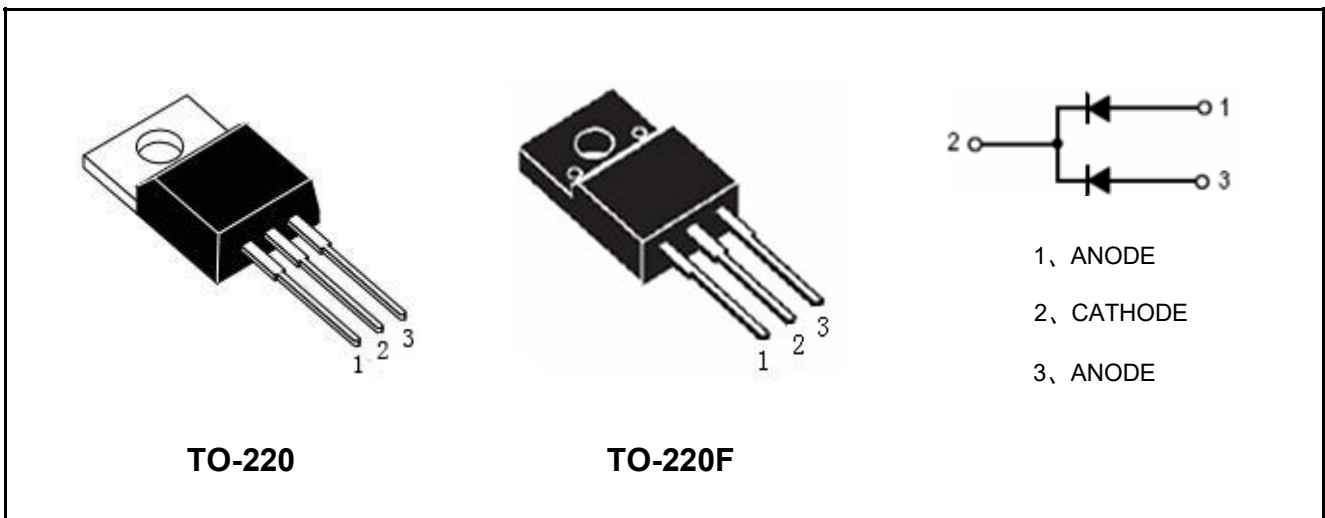

Marking	Package	Packaging	Min. package quantity
MBR1045CT	TO-220	Tube	1000
MBR1045CT	TO-220F	Tube	1000



■ Absolute Maximum Ratings (Tc=25°C unless otherwise noted)

Parameter	Symbol	Ratings	Unit
Peak Repetitive Reverse Voltage	V_{RRM}	45	V
Surge Peak Reverse Voltage	V_{RSM}		V
DC Peak Blocking Voltage	V_R		V
Continuous Forward Current	$I_{F(per\ leg)}$	5	A
	$I_{F(total)}$	10	A
Non-Repetitive Peak Surge Current((Surge applied at rated load conditions halfwave,single phase,60HZ)	I_{FSM}	150	A
Junction Temperature	T_j	150	°C
Storage Temperature	T_{stg}	-55-150	°C

■ Thermal Characteristics

Parameter	Symbol	Package	Max	Unit
Maximum Junction-to-Case	$R_{\theta JC}$	TO-220	2	°C/W
	$R_{\theta JC}$	TO-220F	4	°C/W
Maximum Junction-to-Ambient	$R_{\theta JA}$	TO-220	60	°C/W
	$R_{\theta JA}$	TO-220F	60	°C/W

■ Electrical Characteristics (Per Leg) (Tc=25°C unless otherwise noted)

Parameter	Symbol	Test Condition	Min	Typ	Max	Unit
Forward Voltage	V_F	$I_F=5A, T_J=25^\circ C$	-	-	0.55	V
		$I_F=5A, T_J=125^\circ C$	-	-	0.45	V
Reverse Current	I_R	$V_R=45V, T_J=25^\circ C$	-	0.02	0.1	mA
		$V_R=45V, T_J=125^\circ C$	-	-	6	mA



■ Characteristics Curves

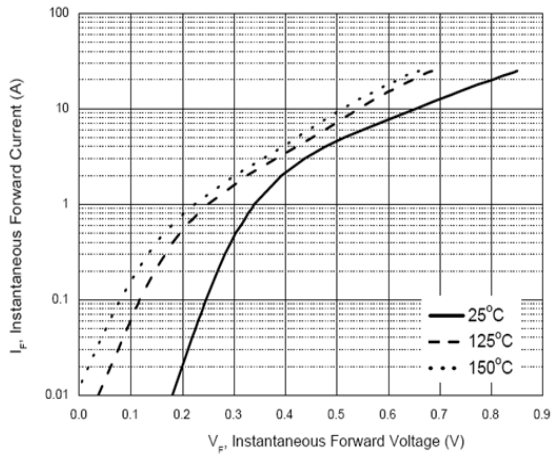

Forward Characteristics Per Diode

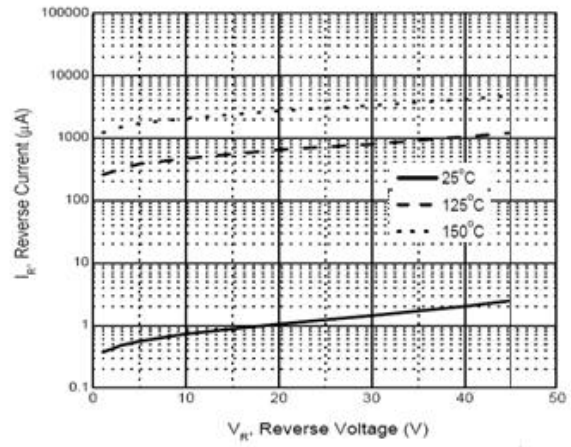

Reverse Characteristics Per Diode

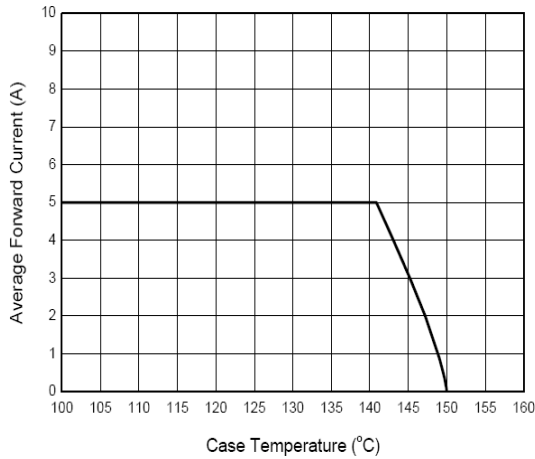

Current Derating Per Diode





■ Reflow Soldering Temperature Profile

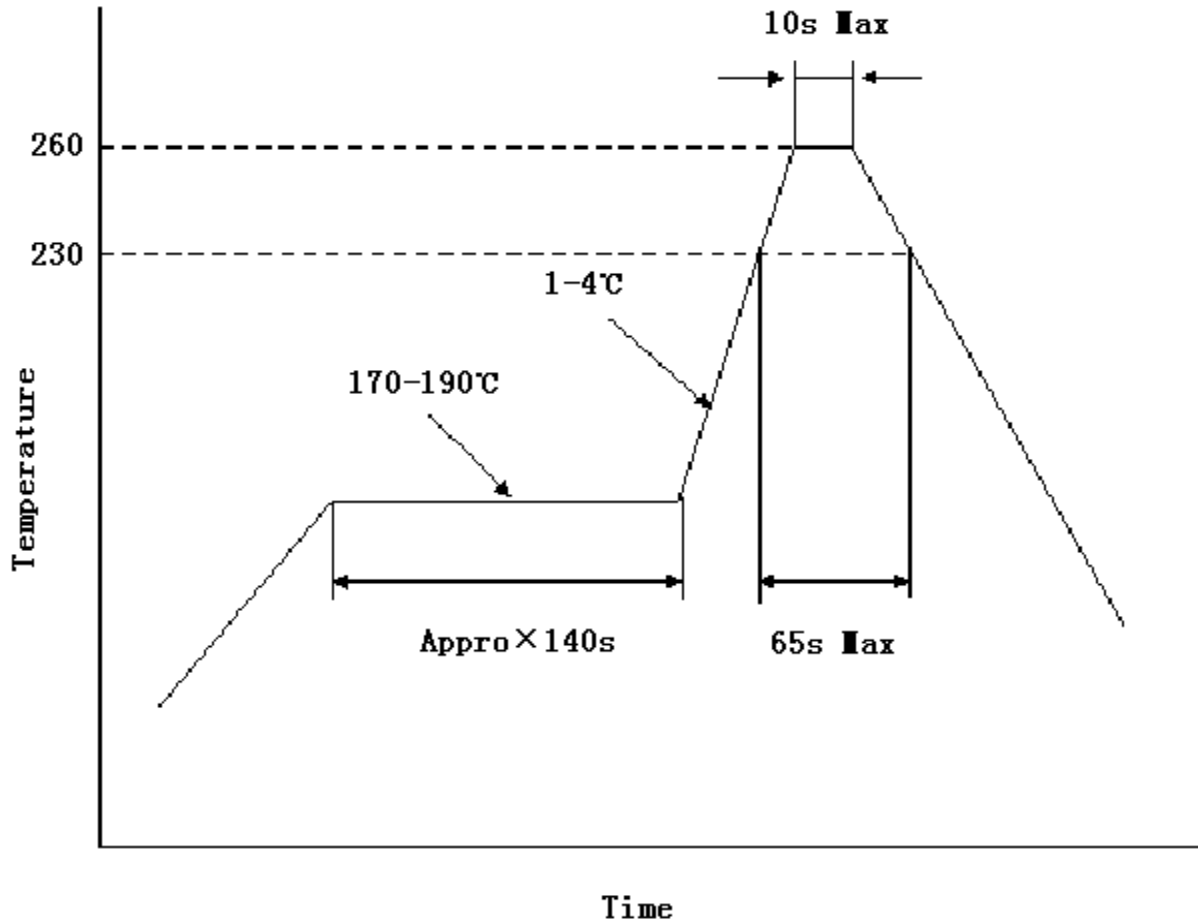

TO-220 Package Dimensions

Unit: mm

Symbol	Min	Nom	Max	Symbol	Min	Nom	Max
A	4.00		4.80	e	2.44	2.54	2.64
B	1.20		1.40	F	1.10		1.40
B1	1.00		1.40	L	12.50		14.50
b1	0.75		0.95	L1	3.00	3.50	4.00
c	0.40		0.55	ΦP	3.70	3.80	3.90
D	15.00		16.50	Q	2.50		3.00
D1	5.90		6.90	Q1	2.00		2.90
E	9.90		10.70	Y	8.02	8.12	8.22

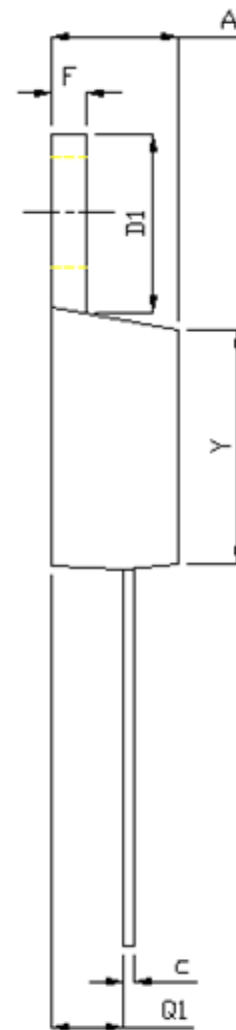
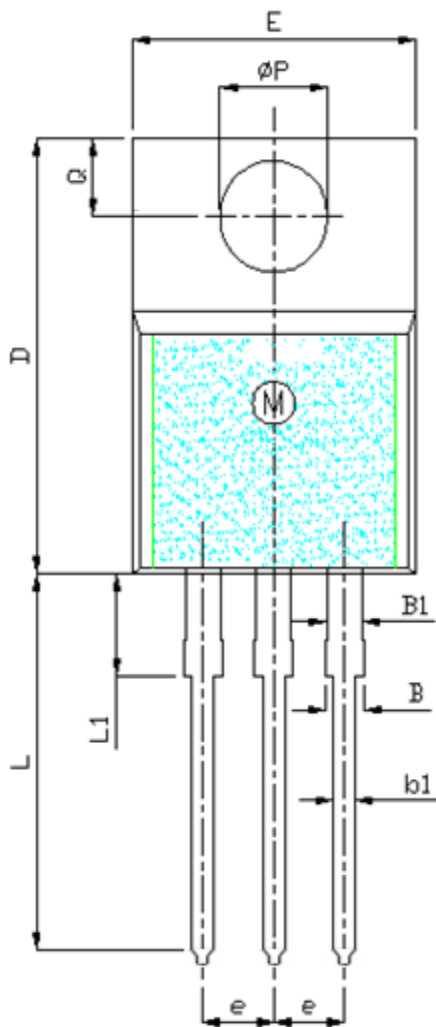

TO-220F Package Dimensions

Unit: mm

Symbol	Min	Nom	Max	Symbol	Min	Nom	Max
A	4.5		4.9	E1	6.5	7	7.5
A1	2.3		2.9	e	2.44	2.54	2.64
b	0.65		0.9	L	12.5		14.3
b1	1.1		1.7	L1	9.45		10.05
b2	1.2		1.4	L2	15		16
c	0.35		0.65	L3	3.2		4.4
D	14.5		16.5	ΦP	3		3.3
D1	6.1		6.9	Q	2.5		2.9
E	9.6		10.3				

