



Applications

- Switch Mode Power Supplies
- High Voltage DC/DC Converters
- Battery Chargers
- Motor Drives
- Pulsed Power applications

Features

- High Blocking Voltage with Low On-Resistance
- High Speed Switching with Low Capacitances
- Easy to Parallel and Simple to Drive
- Avalanche Ruggedness

Benefits

- Higher System Efficiency
- Reduced Cooling Requirements
- Increased Power Density
- Increased System Switching Frequency

Product Summary

V_{DS}	650	V
I_D	11	A
$R_{DS(ON)}, Typ@18V$	140	mΩ
Q_g	29	nC



TO-220F

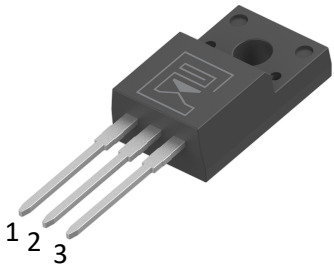

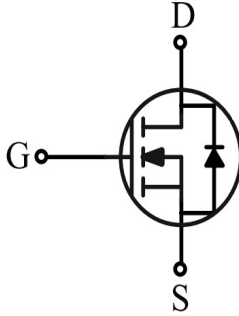

Gate: 1

Drain: 2

Source: 3

Package Marking and Ordering Information

Ordering code	Marking	Package	Packaging	Min. package quantity
MF3C180R065	MF3C180R065	TO-220F	Tube	1000



» Absolute Maximum Ratings (Tc=25°C unless otherwise noted)

Parameter	Symbol	Ratings	Unit
Drain-Source Voltage	V_{DS}	650	V
Gate-Source Voltage	V_{GS}	- 10/+22	V
Recommended operational values	V_{GSop}	0/+18	V
Continuous Drain Current Tc=25°C VGS=18V (Note 1)	I_D	11	A
Continuous Drain Current Tc=100°C VGS=18V (Note 1)		8	A
Drain Current-Pulsed (Note 1)	I_{DM}	22	A
Total Dissipation	P_D	25	W
Junction Temperature	T_j	175	°C
Storage Temperature	T_{stg}	- 55~175	°C
Single Pulse Avalanche Energy (Note 2)	E_{AS}	100	mJ

Note: Using continuously under heavy loads (e.g. the application of high temperature/current/voltage and the significant change in temperature, etc.) may cause this product to decrease in the reliability even if the operating conditions (i.e. operating temperature/current/voltage, etc.) are within the absolute maximum ratings.

» Thermal Characteristics

Parameter	Symbol	Max	Unit
Maximum Junction-to-Case	$R_{\theta JC}$	6	°C/W
Maximum Junction-to-Ambient	$R_{\theta JA}$	80	°C/W

Note 1: Ensure that the channel temperature does not exceed 175°C.

Note 2: VDD=100V, Tch= 25°C(initial), L=0.5mH

Note: This transistor is sensitive to electrostatic discharge and should be handled with care.



» Electrical Characteristics (Tc=25°C unless otherwise noted)

Parameter	Symbol	Test Condition	Min	Typ	Max	Unit
Static Parameters						
Drain-Source Breakdown Voltage	BV_{DSS}	$V_{GS}=0V, I_D=500\mu A$	650	-	-	V
Drain-Source Leakage Current	I_{DSS}	$V_{DS}=650V, V_{GS}=0V$	-	-	1	μA
Gate-Body Leakage Current	I_{GSS}	$V_{GS}=18V, V_{DS}=0V$	-	-	100	nA
Gate Threshold Voltage	$V_{GS(TH)}$	$V_{GS}=V_{DS}, I_{DS}=5mA$	3.0	3.8	5.0	V
Drain-Source On Resistance	$R_{DS(ON)}$	$V_{GS}=15V, I_D=10A$	-	200	240	m Ω
		$T_j=175^\circ C$	-	180	-	
		$V_{GS}=18V, I_D=10A$	-	140	180	
		$T_j=175^\circ C$	-	160	-	
Transconductance	g_{fs}	$V_{GS}=20V, I_D=10A$	-	1.7	-	S
Dynamic Characteristics						
Input Capacitance	C_{iss}	$V_{DS}=25V, V_{GS}=0V,$ $f=1.0MHz$	-	503	-	pF
Output Capacitance	C_{oss}		-	141	-	pF
Reverse Transfer Capacitance	C_{rss}		-	10	-	pF
Gate Resistance	R_g	$V_{DS}=0V, V_{GS}=0V,$ $f=1.0MHz$	-	2.9	-	Ω
Switching Parameters						
Turn-On Delay Time	$t_{d(on)}$	$V_{DD}=500V,$ $V_{GS}=0/15V$ $I_D=8.5A,$ $R_{G(ext)}=10\Omega$	-	15	-	ns
Turn-On Rise Time	t_r		-	55	-	ns
Turn-Off Delay Time	$t_{d(off)}$		-	32	-	ns
Turn-Off Fall Time	t_f		-	70	-	ns
Turn-On Switching Energy	E_{ON}		-	57	-	μJ
Turn-Off Switching Energy	E_{OFF}		-	7.3	-	
Total Gate Charge	Q_g	$V_{DD}=500V$ $V_{GS}=0/15V$ $I_D=8.5A$	-	29	-	nC
Gate-Source Charge	Q_{gs}		-	8.2	-	nC
Gate-Drain Charge	Q_{gd}		-	14.1	-	nC
Source-Drain Characteristics						
Diode Forward Voltage	V_{sd}	$V_{GS}=0V, I_{SD}=5A,$	-	3.4	-	V
Continuous Diode Forward Current	I_S	$T_C=25^\circ C$	-	11	-	A
Reverse Recovery Time	t_{rr}	$V_R=400V, I_F=20A,$ $di/dt=100A/\mu s$	-	26	-	ns
Reverse Recovery Charge	Q_{rr}		-	19.5	-	nC
Peak Reverse Recovery Current	I_{rrm}		-	1.5	-	A



Characteristics Curves

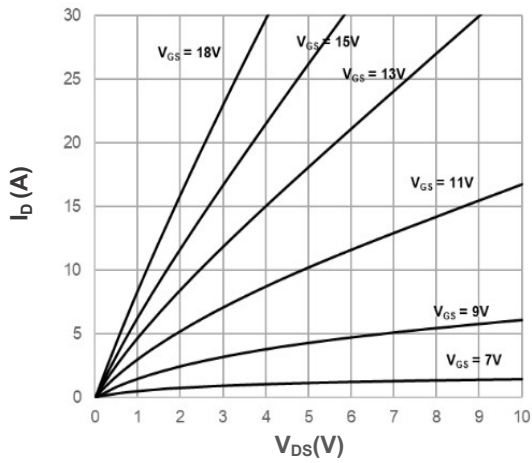

Output Characteritsics $T_J = 25^\circ\text{C}$

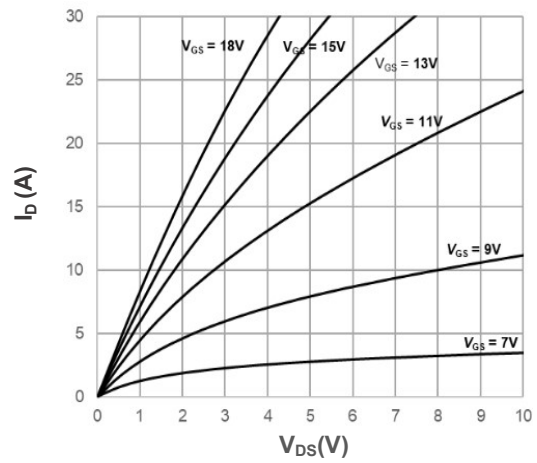

Output Characteritsics $T_J = 175^\circ\text{C}$

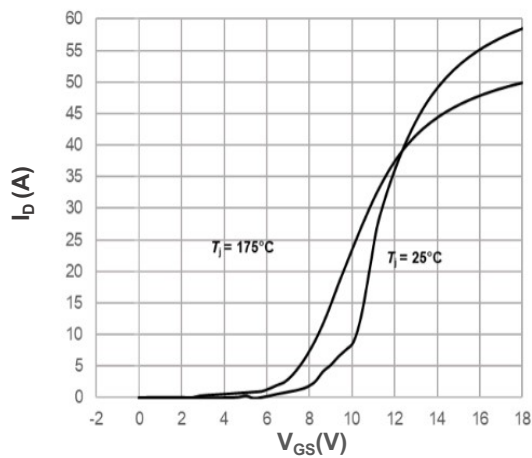

Transfer Characteritsics

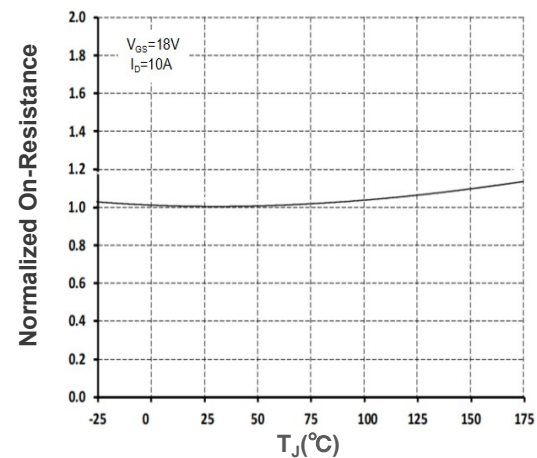

Normalized On-Resistance vs. Temperature

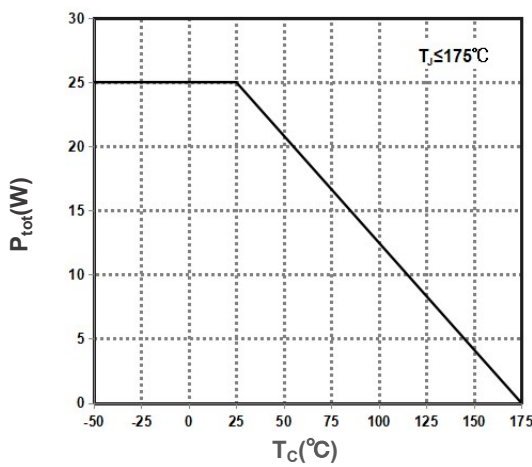

Power Dissipation Derating

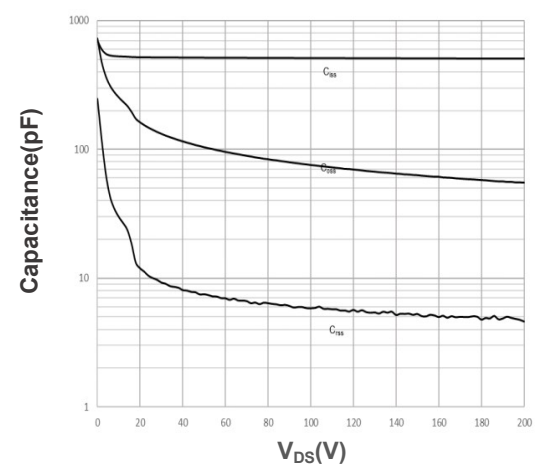

Capacitance

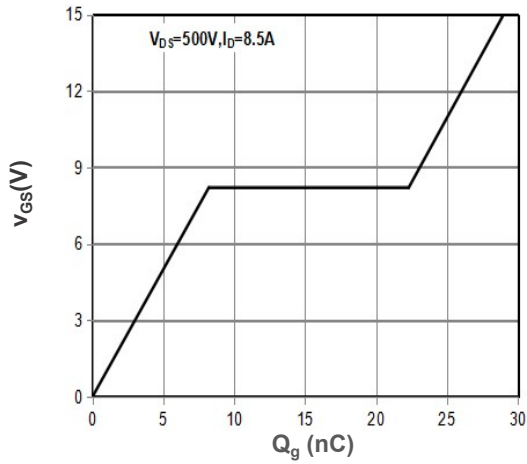

Gate Charge Waveform

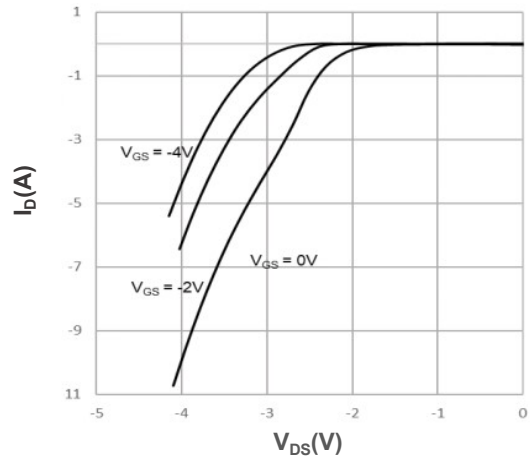

Source-Drain Diode Characteristics, $T_J=25^\circ C$

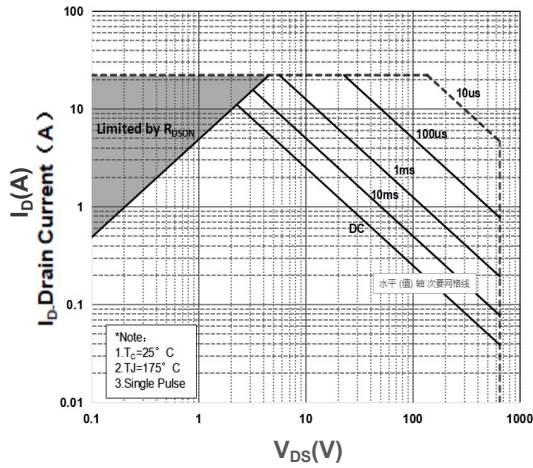

Safe Operating Area

Note: The above characteristics curves are presented for reference only and not guaranteed by production test, unless otherwise noted.



» Test Circuit & Waveform

Gate Charge Test Circuit & Waveform

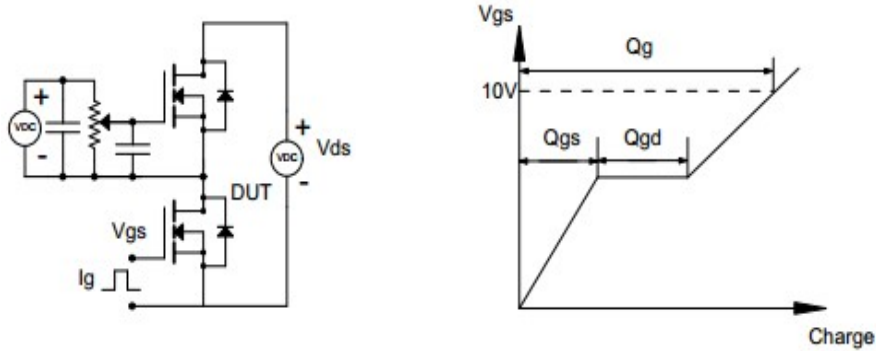

Resistive Switching Test Circuit & Waveform

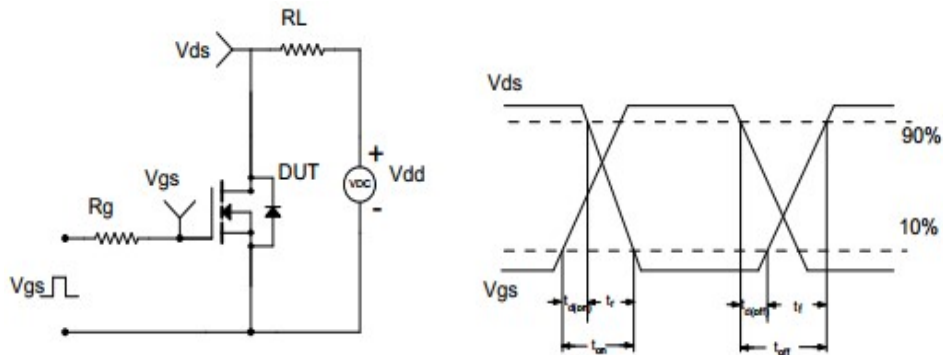

Unclamped Inductive Switching (UIS) Test Circuit & Waveform

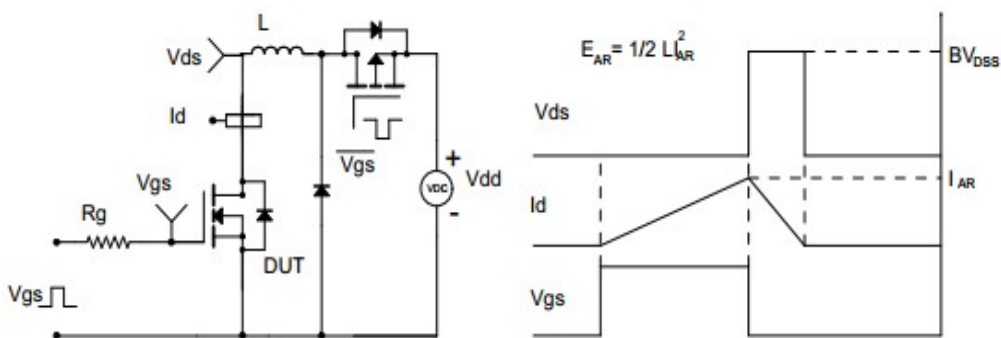



TO-220F Package Dimensions

Unit: mm

Symbol	Min	Nom	Max	Symbol	Min	Nom	Max
A	4.5		4.9	e	2.44	2.54	2.64
A1	2.3		2.9	L	12.5		14.3
b	0.65		0.9	L1	9.45		10.05
b1	1.2		1.4	L2	15		16
c	0.35		0.65	L3	3.2		4.4
D	14.5		16.5	L4	0.7		0.9
D1	6.1		6.9	ΦP	3		3.3
E	9.6		10.3	Q	2.5		2.9
E1	6.5	7	7.5				

