



Applications

- Switch Mode Power Supplies
- High Voltage DC/DC Converters
- Battery Chargers
- Motor Drives
- Pulsed Power applications

Features

- High Blocking Voltage with Low On-Resistance
- High Speed Switching with Low Capacitances
- Easy to Parallel and Simple to Drive
- Avalanche Ruggedness

Benefits

- Higher System Efficiency
- Reduced Cooling Requirements
- Increased Power Density
- Increased System Switching Frequency

Product Summary

V_{DS}	650	V
I_D	9	A
$R_{DS(ON)}$, Typ@18V	400	mΩ
Q_g	28	nC



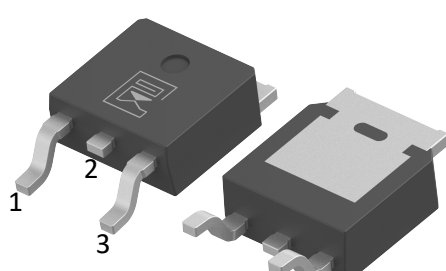

TO-252

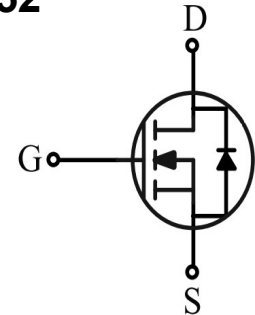

Gate: 1
Drain: 2
Source: 3

Package Marking and Ordering Information

Ordering code	Marking	Package	Packaging	Min. package quantity
MK3C600R065	MK3C600R065	TO-252	Tape & Reel	3000



» **Absolute Maximum Ratings (Tc=25°C unless otherwise noted)**

Parameter	Symbol	Ratings	Unit
Drain-Source Voltage	V_{DS}	650	V
Gate-Source Voltage	V_{GS}	- 10/+22	V
Recommended operational values	V_{GSop}	0/+18	V
Continuous Drain Current Tc=25°C VGS=18V (Note 1)	I_D	9	A
Continuous Drain Current Tc=100°C VGS=18V (Note 1)		6	A
Drain Current-Pulsed (Note 1)	I_{DM}	18	A
Total Dissipation	P_D	52	W
Junction Temperature	T_j	175	°C
Storage Temperature	T_{stg}	- 55~175	°C

Note: Using continuously under heavy loads (e.g. the application of high temperature/current/voltage and the significant change in temperature, etc.) may cause this product to decrease in the reliability even if the operating conditions (i.e. operating temperature/current/voltage, etc.) are within the absolute maximum ratings.

» **Thermal Characteristics**

Parameter	Symbol	Max	Unit
Maximum Junction-to-Case	$R_{\theta JC}$	2.9	°C/W
Maximum Junction-to-Ambient	$R_{\theta JA}$	60	°C/W

Note 1: Ensure that the channel temperature does not exceed 175°C.

Note: This transistor is sensitive to electrostatic discharge and should be handled with care.



Electrical Characteristics (Tc=25°C unless otherwise noted)

Parameter	Symbol	Test Condition	Min	Typ	Max	Unit
Static Parameters						
Drain-Source Breakdown Voltage	BV_{DSS}	$V_{GS}=0V, I_D=500\mu A$	650	-	-	V
Drain-Source Leakage Current	I_{DSS}	$V_{DS}=650V, V_{GS}=0V$	-	-	1	μA
Gate-Body Leakage Current	I_{GSS}	$V_{GS}=18V, V_{DS}=0V$	-	-	100	nA
Gate Threshold Voltage	$V_{GS(TH)}$	$V_{GS}=V_{DS}, I_{DS}=1.3mA$	2.5	3.3	4.0	V
Drain-Source On Resistance	$R_{DS(ON)}$	$V_{GS}=15V, I_D=3.5A$	-	540	640	m Ω
		$T_j=175^\circ C$	-	480	-	
		$V_{GS}=18V, I_D=3.5A$	-	400	500	
		$T_j=175^\circ C$	-	460	-	
Transconductance	g_{fs}	$V_{GS}=20V, I_D=3A$	-	0.6	-	S
Dynamic Characteristics						
Input Capacitance	C_{iss}	$V_{DS}=25V, V_{GS}=0V,$ $f=1.0MHz$	-	169	-	pF
Output Capacitance	C_{oss}		-	46	-	pF
Reverse Transfer Capacitance	C_{rss}		-	3	-	pF
Gate Resistance	R_g	$V_{DS}=0V, V_{GS}=0V,$ $f=1.0MHz$	-	6	-	Ω
Switching Parameters						
Turn-On Delay Time	$t_{d(on)}$	$V_{DD}=500V,$ $V_{GS}=0/15V$ $I_D = 3.5A,$ $R_{G(ext)} = 10\Omega$	-	15	-	ns
Turn-On Rise Time	t_r		-	39	-	ns
Turn-Off Delay Time	$t_{d(off)}$		-	16	-	ns
Turn-Off Fall Time	t_f		-	69	-	ns
Turn-On Switching Energy	E_{ON}		-	35	-	μJ
Turn-Off Switching Energy	E_{OFF}		-	4.1	-	
Total Gate Charge	Q_g	$V_{DD}=500V$ $V_{GS}=0/15V$ $I_D = 3.5A$	-	28	-	nC
Gate-Source Charge	Q_{gs}		-	9	-	nC
Gate-Drain Charge	Q_{gd}		-	4	-	nC
Source-Drain Characteristics						
Diode Forward Voltage	V_{sd}	$V_{GS} = 0V, I_{SD} = 2A$	-	4	-	V
Continuous Diode Forward Current	I_S	$T_C=25^\circ C$	-	9	-	A
Reverse Recovery Time	t_{rr}	$V_R=400V, I_F=5A,$ $di/dt=400A/\mu s$	-	10.4	-	ns
Reverse Recovery Charge	Q_{rr}		-	11	-	nC
Peak Reverse Recovery Current	I_{rrm}		-	2.1	-	A



Characteristics Curves

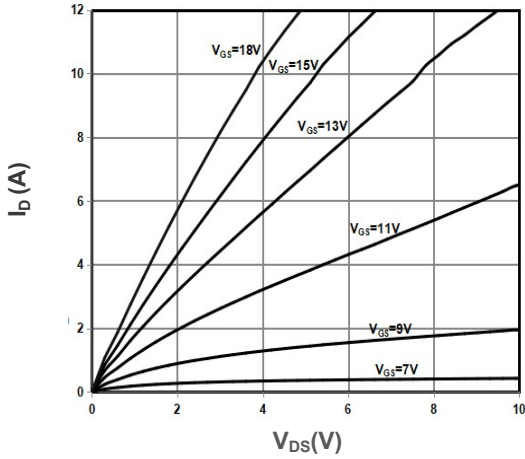

Output Characteristics $T_J = 25^\circ\text{C}$

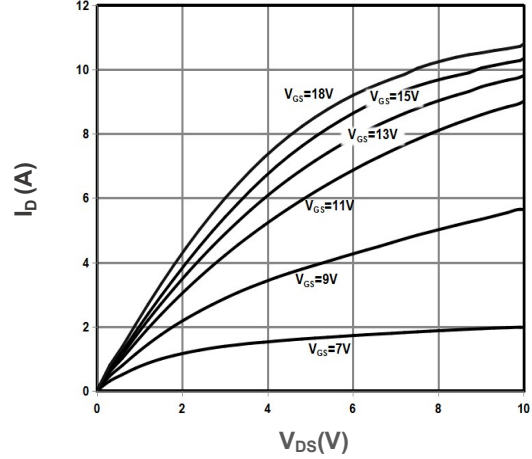

Output Characteristics $T_J = 175^\circ\text{C}$

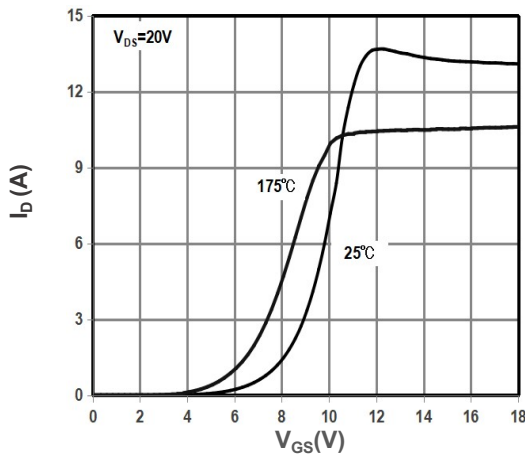

Transfer Characteristics

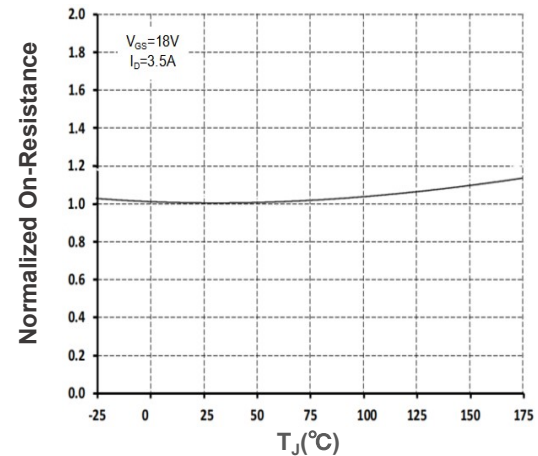

Normalized On-Resistance vs. Temperature

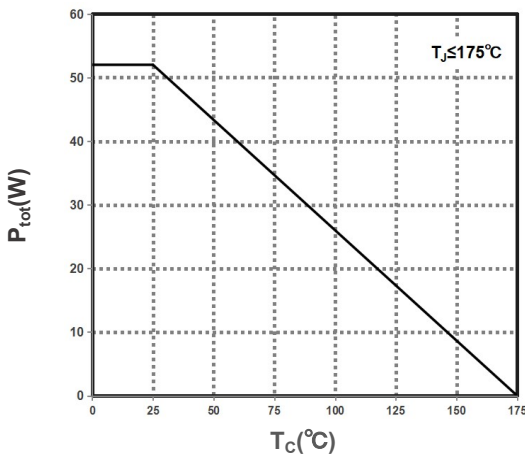

Power Dissipation Derating

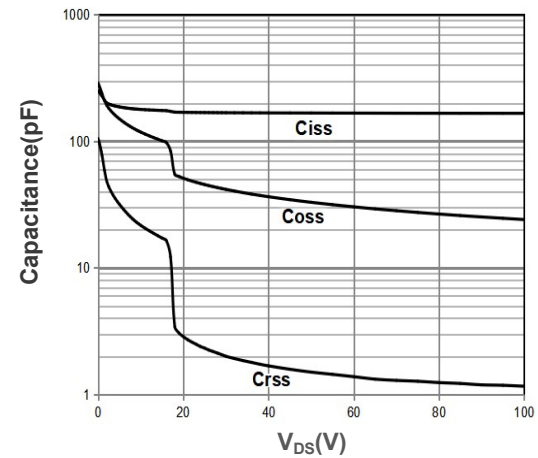

Capacitance

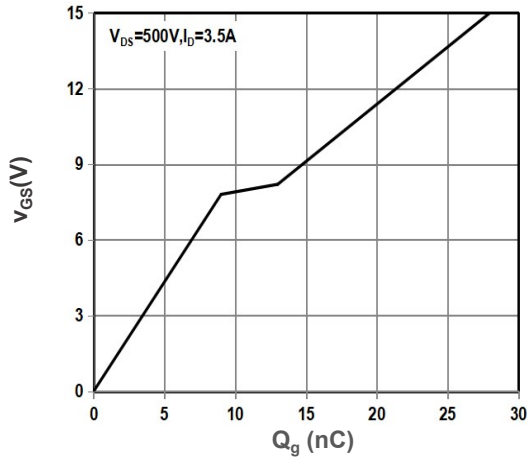

Gate Charge Waveform

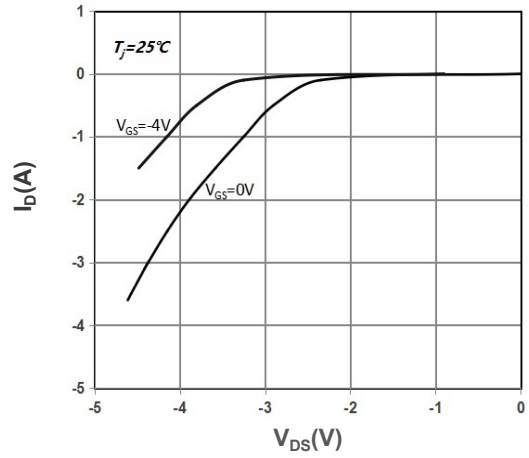

Source-Drain Diode Characteristics, $T_j=25^\circ C$

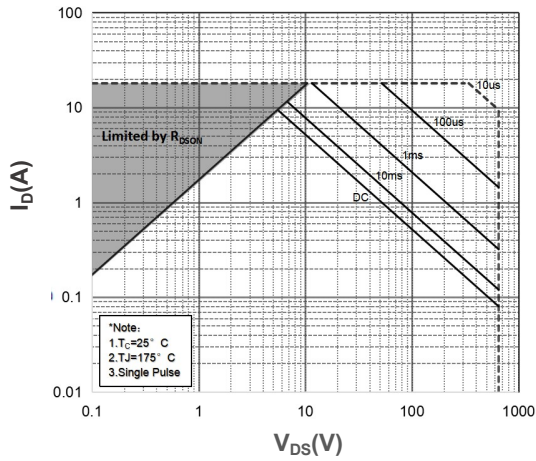

Safe Operating Area

Note: The above characteristics curves are presented for reference only and not guaranteed by production test, unless otherwise noted.



» Test Circuit & Waveform

Gate Charge Test Circuit & Waveform

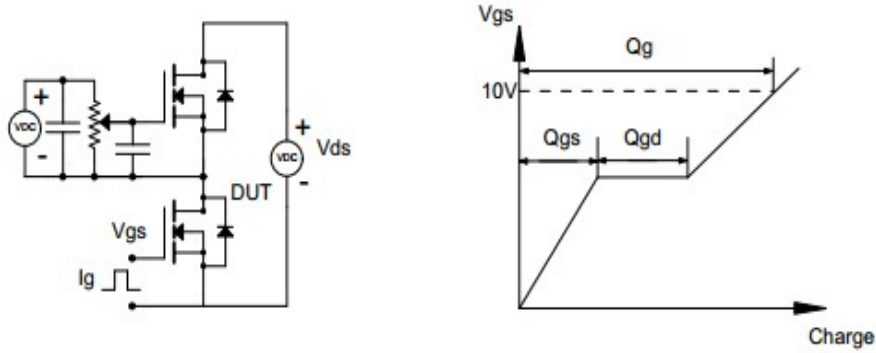

Resistive Switching Test Circuit & Waveform

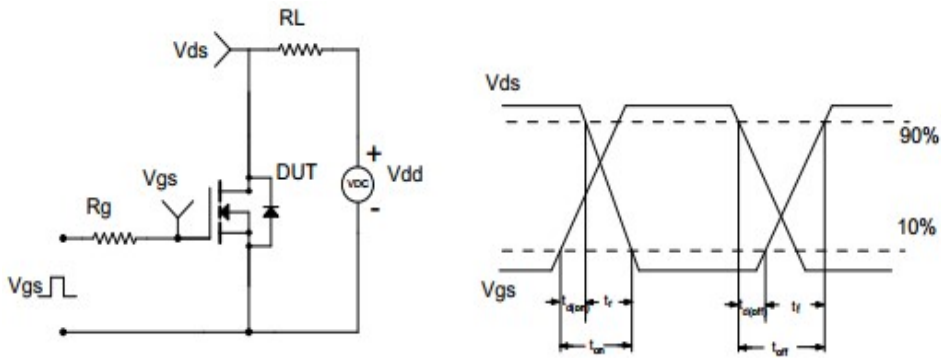

Unclamped Inductive Switching (UIS) Test Circuit & Waveform

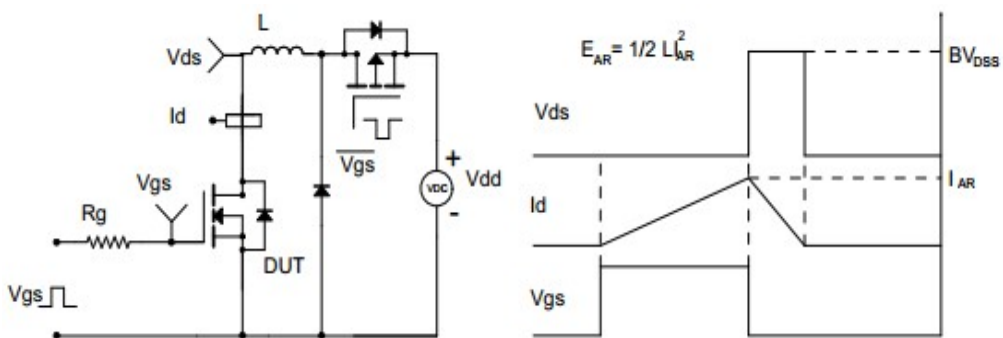



» TO-252 Package Dimensions

Unit: mm

Symbol	Min	Nom	Max	Symbol	Min	Nom	Max
A	2.20		2.40	L	9.80		10.40
A1	0.00		0.13	L1		2.90	
b	0.66		0.86	L2	1.40		1.60
c	0.46		0.58	L3		1.80	
D	6.50		6.70	L4	0.60		1.00
D1	5.10		5.46	L5	0.90		1.25
D2		4.83		Φ	1.1		1.30
E	6.00		6.20	θ	0°		8°
e	2.19		2.39	V		5.35	

