

» Applications

- Power factor correction (PFC)
- Switched mode power supplies(SMPS)
- Uninterruptible Power Supply (UPS)

» Product Summary

$V_{DS} @ T_{J,max}$	550	V
I_D	15	A
$R_{DS(ON), Typ @ 10V}$	0.2	Ω
Q_g	20	nC

» Features

- Multi-Epi process SJ-FET
- Low $R_{DS(ON)}$
- Ultra Low Gate Charge
- 100% UIS and RG Tested

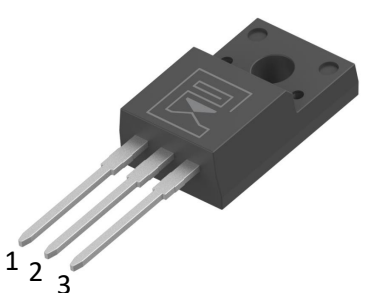
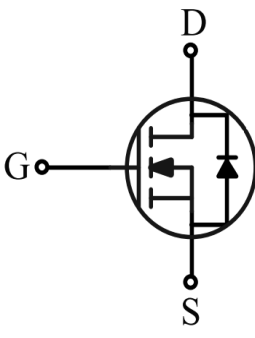

TO-220F

Gate: 1

Drain: 2

Source: 3

» Package Marking and Ordering Information

Ordering code	Marking	Package	Packaging	Min. package quantity
MHF240R50C	MHF240R50C	TO-220F	Tube	1000

»» Absolute Maximum Ratings (Tc=25°C unless otherwise noted)

Parameter	Symbol	Ratings	Unit
Drain-Source Voltage	V_{DS}	500	V
Gate-Source Voltage	V_{GS}	±30	V
Continuous Drain Current Tc=25°C (Note 1)	I_D	15	A
Continuous Drain Current Tc=100°C (Note 1)		9	
Drain Current-Pulsed (Note 1)	I_{DM}	43	A
Total Dissipation	P_D	35	W
Junction Temperature	T_j	150	°C
Storage Temperature	T_{stg}	-55-150	°C
Single Pulse Avalanche Energy (Note 2)	E_{AS}	284	mJ

Note: Using continuously under heavy loads (e.g. the application of high temperature/current/voltage and the significant change in temperature, etc.) may cause this product to decrease in the reliability significantly even if the operating conditions (i.e. operating temperature/current/voltage, etc.) are within the absolute maximum ratings.

»» Thermal Characteristics

Parameter	Symbol	Max	Unit
Maximum Junction-to-Case	$R_{\theta JC}$	3.57	°C/W
Maximum Junction-to-Ambient	$R_{\theta JA}$	80	°C/W

Note 1: Ensure that the channel temperature does not exceed 150°C.

Note 2: $V_{DD}=50V$, $T_{ch}=25^{\circ}C$ (initial), $I_{AS}=18A$, $R_g=25\Omega$.

Note: This transistor is sensitive to electrostatic discharge and should be handled with care.

Electrical Characteristics (Tc=25°C unless otherwise noted)

Parameter	Symbol	Test Condition	Min	Typ	Max	Unit
Static Parameters						
Drain-Source Breakdown Voltage	BV _{DSS}	V _{GS} =0V, I _D =250uA	500	-	-	V
		T _j =150°C	550	-	-	
Drain-Source Leakage Current	I _{DSS}	V _{DS} =500V, V _{GS} =0V	-	-	1	uA
Gate-Body Leakage Current	I _{GSS}	V _{GS} =±30V, V _{DS} =0V	-	-	±100	nA
Gate Threshold Voltage	V _{GS(TH)}	V _{GS} =V _{DS} , I _D =250uA	2.5	3.5	4.5	V
Drain-Source On Resistance	R _{DS(ON)}	V _{GS} =10V, I _D =9A	-	0.20	0.24	Ω
		T _j =150°C	-	0.54	-	
Dynamic Characteristics						
Input Capacitance	C _{iss}	V _{DS} =25V, V _{GS} =0V, f=1.0MHz	-	815	-	pF
Output Capacitance	C _{oss}		-	350	-	pF
Reverse Transfer Capacitance	C _{rss}		-	10	-	pF
Gate Resistance	R _g	V _{DS} =0V, V _{GS} =0V, f=1.0MHz	-	3.8	-	Ω
Switching Paramters						
Turn-On Delay Time	t _{d(on)}	V _{DS} =400V, I _D =9A, V _{GS} =10V, R _G =25Ω	-	13	-	ns
Turn-On Rise Time	t _r		-	12	-	ns
Turn-Off Delay Time	t _{d(off)}		-	100	-	ns
Turn-Off Fall Time	t _f		-	12	-	ns
Total Gate Charge	Q _g	V _{DS} =400V, I _D =9A, V _{GS} =10V	-	20	-	nC
Gate-Source Charge	Q _{gs}		-	5	-	nC
Gate-Drain Charge	Q _{gd}		-	7.5	-	nC
Source-Drain Characteristics						
Max. Diode Forward Current	I _s		-	-	18	A
Max. Pulsed Forward Current	I _{SM}		-	-	43	A
Diode Forward Voltage	V _{sd}	V _{GS} =0V, I _S =9A	-	0.9	1.5	V
Reverse Recovery Time	t _{rr}	V _R =400V, I _F =9A, di/dt=100A/us	-	340	-	ns
Reverse Recovery Charge	Q _{rr}		-	4.5	-	μC



Characteristics Curves

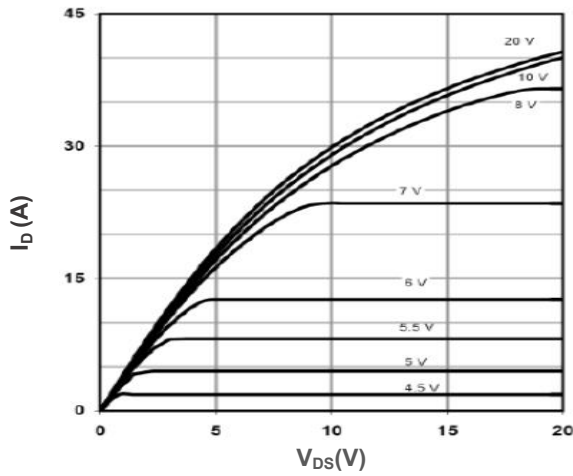

Output Characteristics

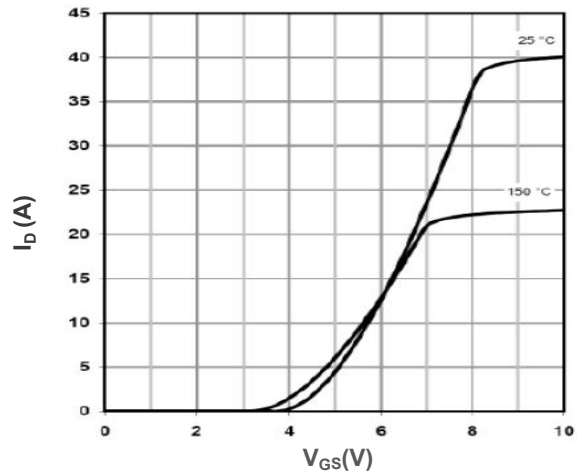

Transfer Characteristics

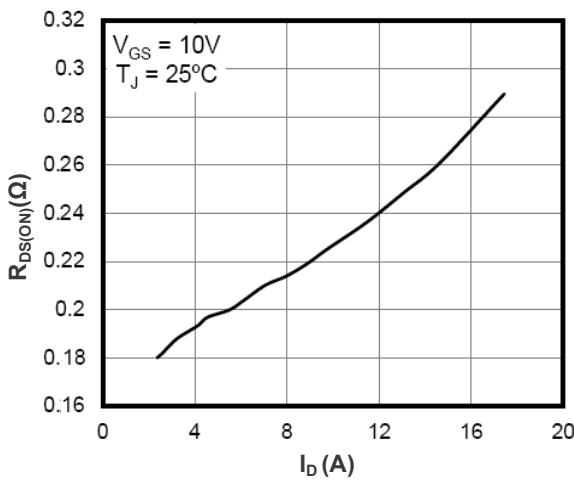

On Resistance Vs Drain Current

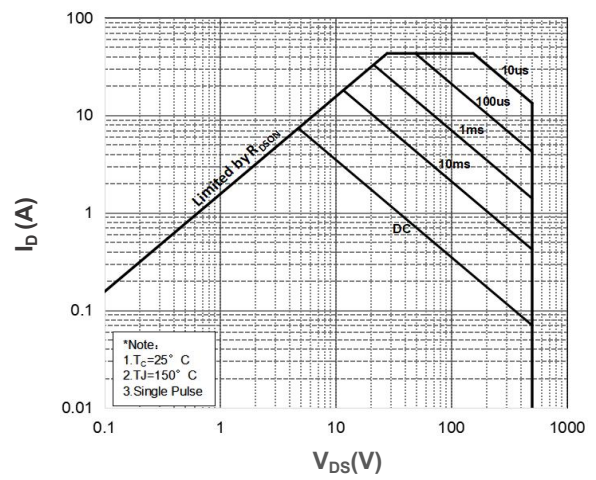

Maximum Safe Operating Area

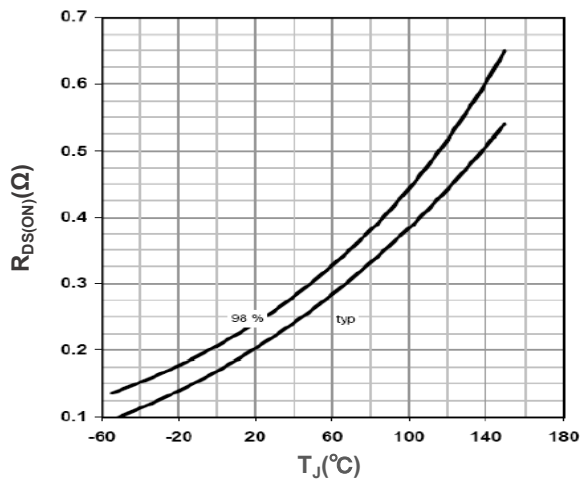

Rdson-Junction Temperature

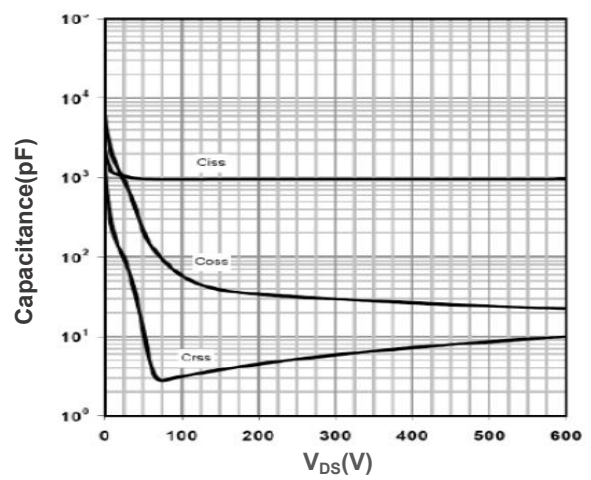

Capacitance

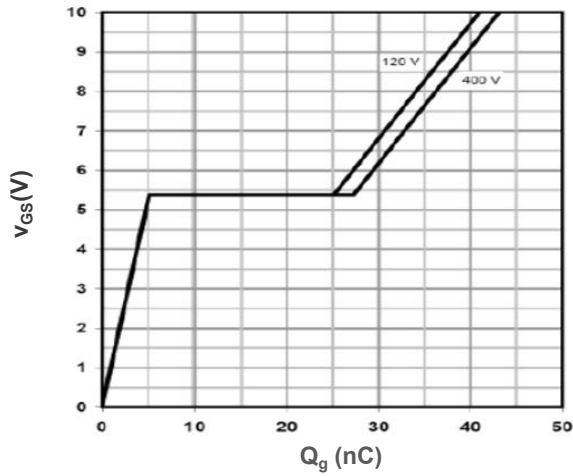

Gate Charge Waveform

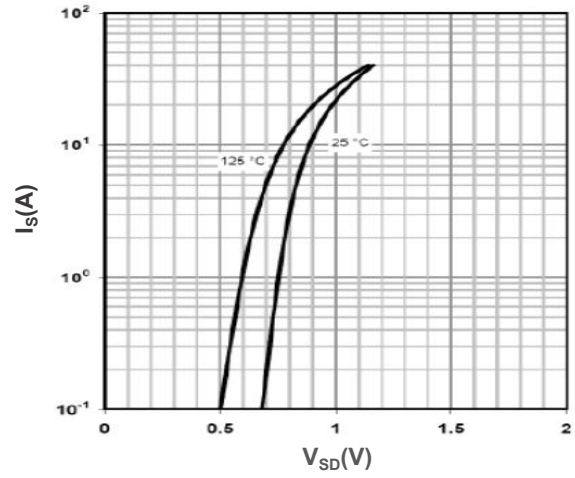

Source-Drain Diode Forward Voltage

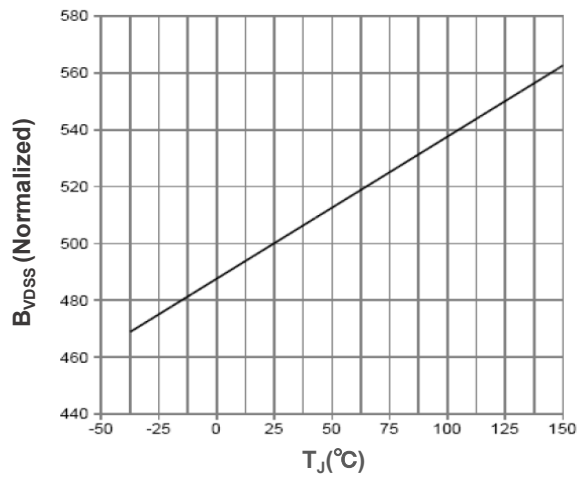

Breakdown Voltage Vs Junction Temperature

Note : The above characteristics curves are presented for reference only and not guaranteed by production test, unless otherwise noted.



Test Circuit & Waveform

Gate Charge Test Circuit & Waveform

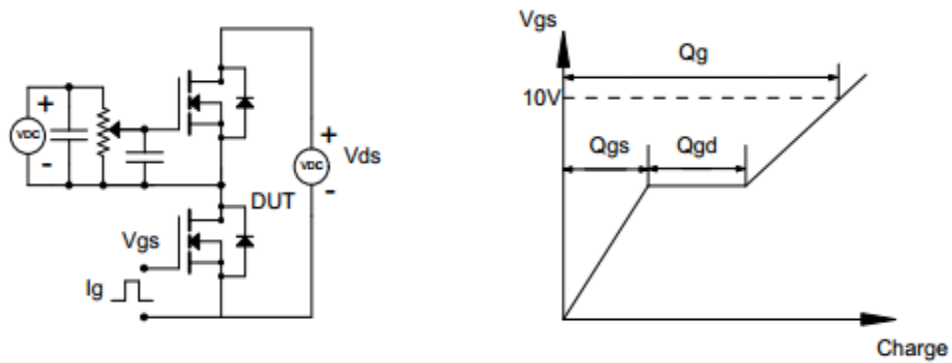

Resistive Switching Test Circuit & Waveform

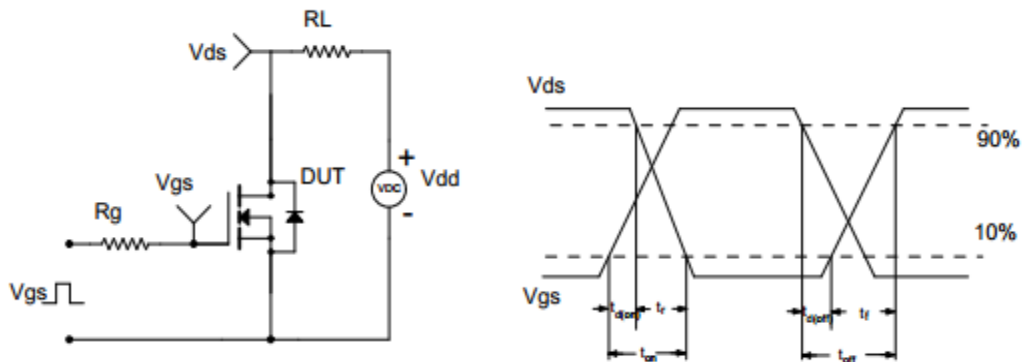

Unclamped Inductive Switching (UIS) Test Circuit & Waveform

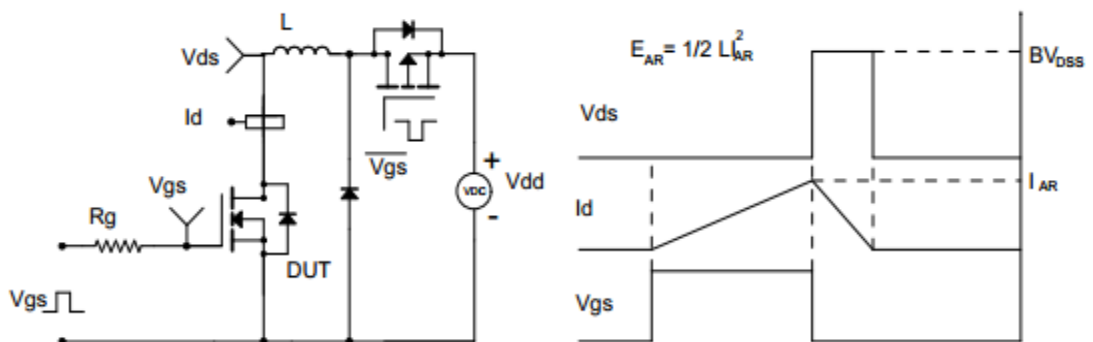



TO-220F Package Dimensions

Unit: mm

Symbol	Min	Nom	Max	Symbol	Min	Nom	Max
A	4.5		4.9	E1	6.5	7	7.5
A1	2.3		2.9	e	2.44	2.54	2.64
b	0.65		0.9	L	12.5		14.3
b1	1.1		1.7	L1	9.45		10.05
b2	1.2		1.4	L2	15		16
c	0.35		0.65	L3	3.2		4.4
D	14.5		16.5	ΦP	3		3.3
D1	6.1		6.9	Q	2.5		2.9
E	9.6		10.3				

